

CRAFTSMAN®

OPERATOR'S MANUAL

Pressure Washer

CMXGWAS020734



IF YOU HAVE ANY QUESTIONS OR COMMENTS, CONTACT US.

1-888-331-4569

WWW.CRAFTSMAN.COM

Copyright © 2020. Briggs & Stratton Corporation
Milwaukee, WI, USA. All rights reserved.

CRAFTSMAN® is a registered trademark of Stanley Black & Decker, Inc., used under license.

Manual No. 80030723 Revision B

Symbols and Meanings

Table of Contents





Symbols and Meanings	2
Equipment Description	3
Features and Controls	4
Operation	6
Maintenance	12
Storage	15
Troubleshooting	16
Warranty	17









Register Your Product

To ensure prompt and complete warranty coverage, register your product online at www.Craftsman.com/registration.

Symbols and Meanings

Signal	Meaning
DANGER	Indicates a hazard which, if not avoided, <i>will</i> result in death or serious injury.
WARNING	Indicates a hazard which, if not avoided, <i>could</i> result in death or serious injury.
CAUTION	Indicates a hazard which, if not avoided, <i>could</i> result in minor or moderate injury.
NOTICE	Indicates information considered important, but not hazard-related.

Symbol	Name	Explanation
	Safety Alert Symbol	Indicates a potential personal injury hazard.
	Read Operator's Manual	Failure to follow warnings, instructions and operator's manual could result in death or serious injury.
	Toxic Fumes	Engine exhaust contains carbon monoxide, a poisonous gas that could kill you in minutes. You cannot smell it or see it.
	Fire	Fuel and its vapors are extremely flammable which could cause burns or fire resulting in death or serious injury. Engine exhaust could cause fire resulting in death or serious injury.

Symbol	Name	Explanation
	Fluid Injection	High-pressure water could cut through skin resulting in serious injury and possible amputation.
	Spray, Flying Objects	Risk of eye injury. Spray could splash back or propel objects resulting in serious injury.
	Hot Surface	Contact with muffler area could cause burns resulting in serious injury.
	Electric Shock	Contact with power source could cause electrical shock resulting in death or serious injury.
	Kickback	Recoil starter kickback will pull hand and arm toward engine faster than you can let go which could cause broken bones, sprains or bruises resulting in serious injury.
	Chemical Burn	Chemicals could cause burns resulting in death or serious injury.
	Slippery Surface/Fall	Slippery wet surfaces could cause you to fall resulting in death or serious injury.
	Fall	Kickback from spray gun could cause you to fall resulting in death or serious injury.

 **WARNING!** This product can expose you to chemicals including gasoline engine exhaust, which is known to the State of California to cause cancer, and carbon monoxide, which is known to the State of California to cause birth defects or other reproductive harm. For more information go to www.P65Warnings.ca.gov.

 **WARNING!** This product contains lead and lead compounds, known to the state of California to cause birth defects or other reproductive harm. Wash your hands after handling this product. Cancer and Reproductive Harm - www.P65Warnings.ca.gov

Equipment Description



Read this manual carefully and become familiar with your product. Know its applications, its limitations, and any hazards involved. Save these original instructions for future reference.

To aid in outdoor cleaning projects, this engine-driven, high-pressure cleaning machine uses a variety of spray tips and detergent.

Know how to stop the product and reduce pressure quickly. Keep operating area clear and do not allow children to operate pressure washer.

Stay alert—watch what you are doing. Do not operate pressure washer when fatigued or under the influence of alcohol or drugs.

Every effort has been made to ensure that information in this manual is accurate and current. However, we reserve the right to change, alter, or otherwise improve the product and this document at any time without prior notice.

NOTICE If you have questions about intended use, contact an authorized service dealer. This equipment is designed to be used with Briggs & Stratton® authorized parts only.

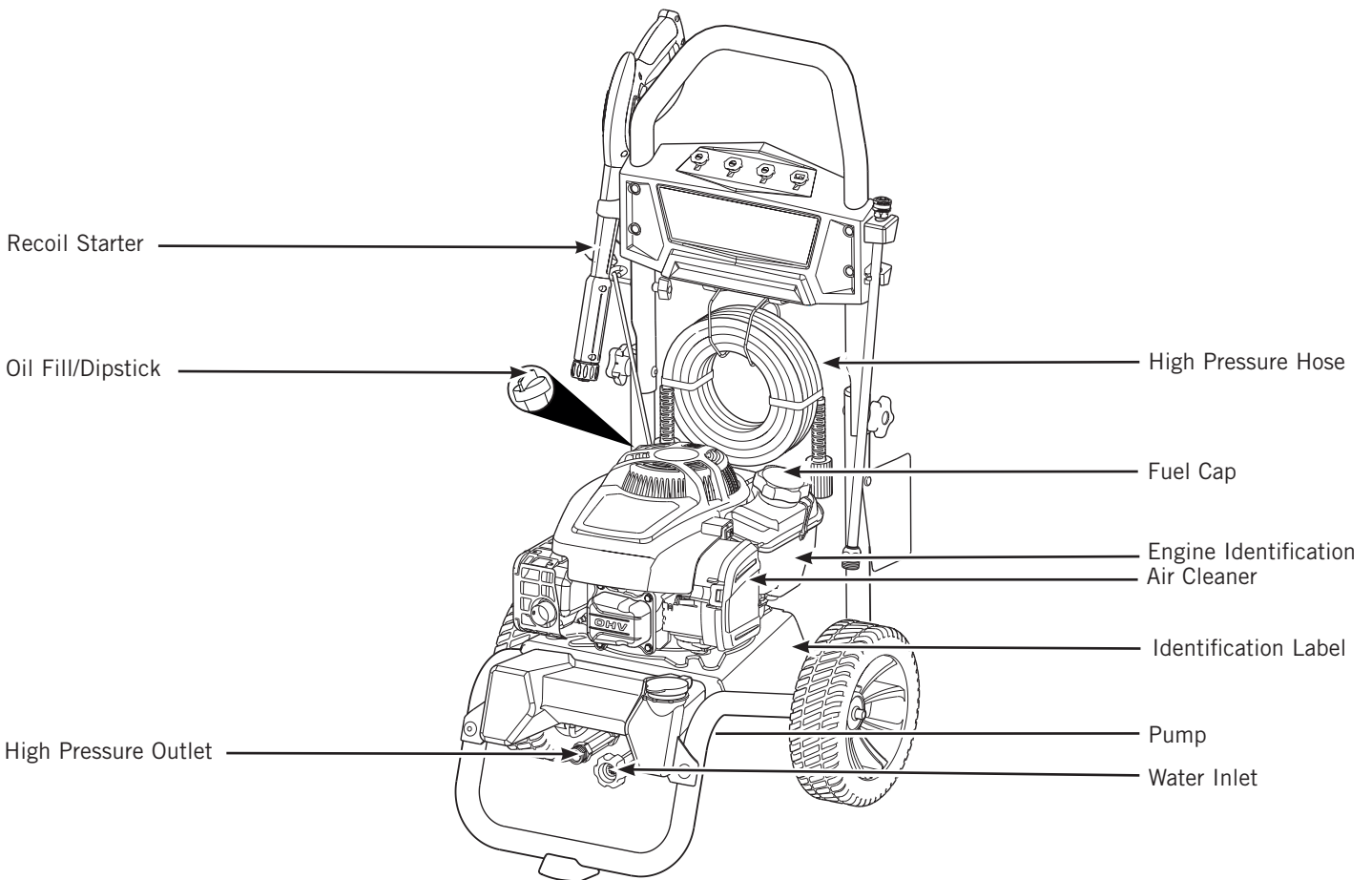

Air Cleaner — Filters engine intake air.

Engine Identification — Provides model, type and code of engine.

Fuel Cap — Add unleaded fuel here.

High Pressure Hose — Connect one end to water pump and the other end to spray gun.

High Pressure Outlet — Connection for high pressure hose.

Identification Label — Provides model and serial number of pressure washer.

Oil Fill/Dipstick — Check, fill and drain oil here.

Pump — Stainless steel piston, axial cam pump that develops high pressure.

Recoil Starter — Used to start the engine.

Water Inlet — Connection for garden hose.

Features and Controls

Compare the illustrations with your pressure washer to familiarize yourself with the locations of various controls and product warnings.

WARNING

Fire Hazard. Operation of this equipment may create sparks that can start fires around dry vegetation. A spark arrestor may be required. The operator should contact local fire agencies for laws or regulations relating to fire prevention requirements. 80008183

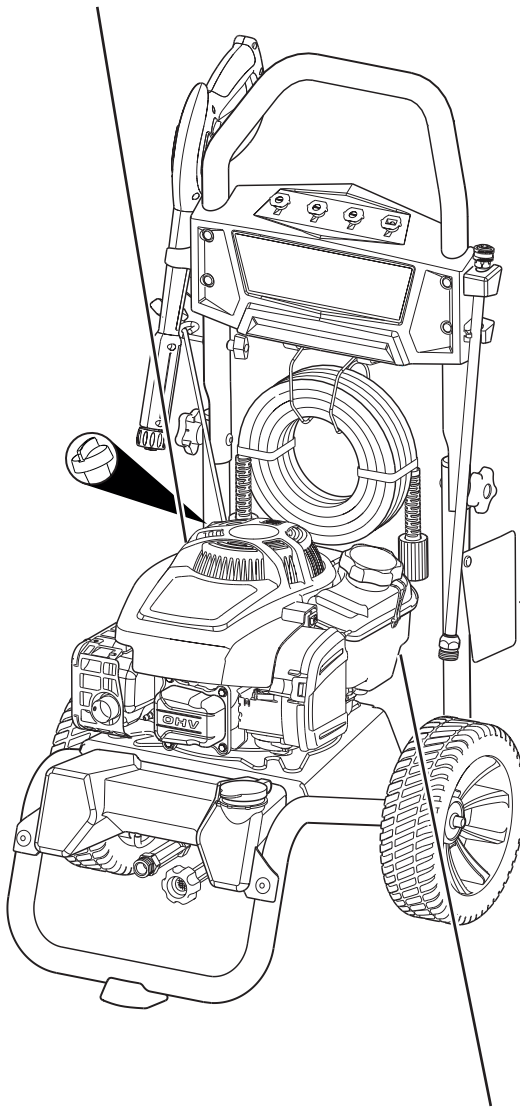

WARNING

- Failure to read and follow the operator's manual, all warnings and operating instructions could result in death or serious injury.
- Engine exhaust contains carbon monoxide, a poisonous gas that could kill you in minutes. You cannot see or smell it. Only use outside far away from windows, doors and vents.
- Gasoline is flammable. Allow engine to cool at least 2 minutes before refueling. Do not spray flammable liquids.
- High pressure could cut through skin. Never spray people. Spray gun traps high water pressure, even after engine is shut down and water is disconnected. Squeeze trigger, to release high pressure, every time engine stops.
- Rapid retraction of starter cord (kickback) could pull hand and arm toward engine faster than you can let go. Pull starter cord slowly until resistance is felt and then pull rapidly to avoid kickback. Gun kicks back — Hold with both hands.
- Spray could splash back or propel objects. Wear safety goggles and protective clothing. Safety glasses do not provide full protection.
- Muffler could cause burns. Do not touch hot parts. Avoid hot exhaust gases.

Do Not Remove This Tag

See reverse side for operating instructions.

- 1** Check engine oil and gas.
- 2** Connect high pressure hose to gun and unit.
- 3** Connect garden hose to unit and water supply. Turn on water.
- 4** Point gun in safe direction, squeeze trigger to purge air from system.
- 5** Connect wand to gun and nozzle to wand.
- 6** Set engine switch to ON (I).
- 7** If equipped, press primer ball 3X. Push starter button or pull cord slowly until resistance is felt, then pull rapidly.

STOP OFF (O) Set engine switch to OFF (O).

Point gun in safe direction, squeeze trigger to release high pressure.

80079235

WARNING

- Read and follow Operating Instructions before running or servicing engine.
- Gasoline is flammable. Allow engine to cool at least 2 minutes before refueling.
- Engines emit carbon monoxide, DO NOT run in enclosed area.

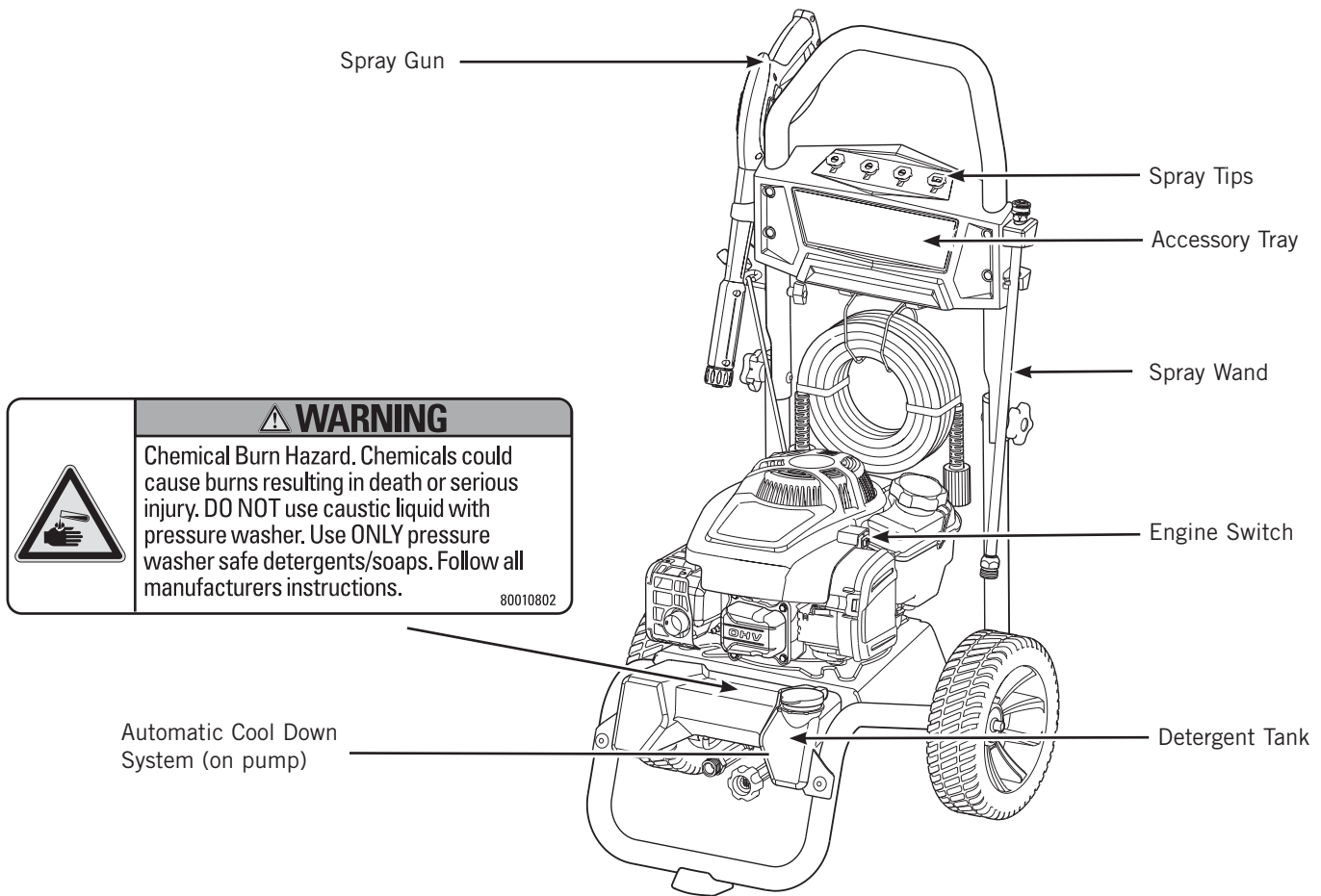

Accessory Tray — Provides convenient storage for accessories and one 4 fl. oz. (0.1 L) can of pump saver (not included).

Automatic Cool Down System — Prevents internal pump damage by discharging warm water to the ground.

Detergent Tank — Holds pressure washer safe detergent.

Engine Switch — Set switch to ON (I) before starting engine. Set switch to OFF (O) to shut off engine.

Spray Wand — Allows you to switch between spray tips.

Spray Gun — Controls spray using trigger. Includes trigger lock.

Spray Tips — Multiple patterns for various cleaning applications.

Operation

Operation

Step 1: Safe Location

Before starting the pressure washer, there are two equally important safety concerns regarding carbon monoxide poisoning and fire that must be addressed.

Operation Location to Reduce the Risk of Carbon Monoxide Poisoning

The engine exhaust of all fossil fuel burning equipment, such as a pressure washer, contains carbon monoxide, a poisonous gas that could kill you in minutes. You cannot smell it, see it, or taste it. Even if you do not smell exhaust fumes, you could still be exposed to carbon monoxide gas.

By law, it is required in many states to have a carbon monoxide alarm in operating condition in your home. A carbon monoxide alarm is an electronic device that detects hazardous levels of carbon monoxide. When there is a buildup of carbon monoxide, the alarm will alert the occupants by flashing a visual indicator light and an alarm. Smoke alarms cannot detect carbon monoxide gas.

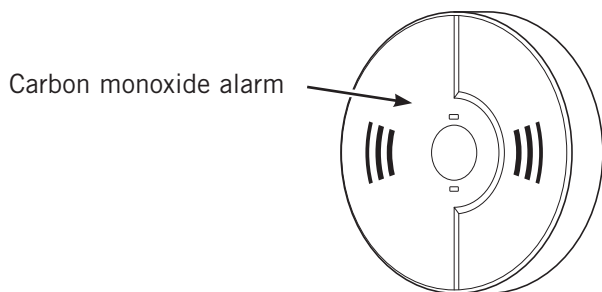

USE OUTDOORS - AVOID CARBON MONOXIDE POISONING

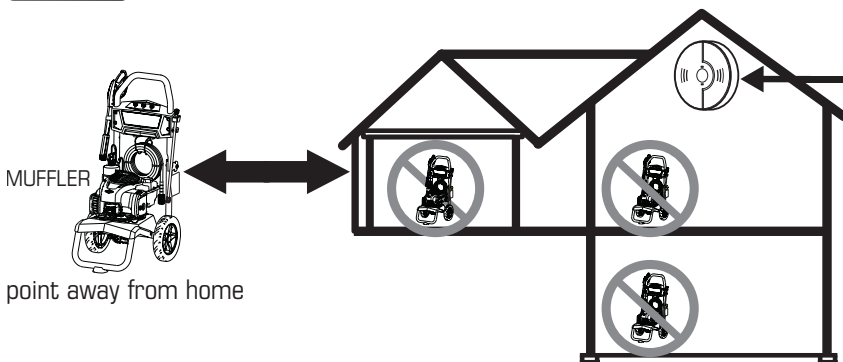

CARBON MONOXIDE ALARM(S)

Install carbon monoxide alarms inside your home. Without working carbon monoxide alarms, you may not realize you are getting sick and dying from carbon monoxide poisoning.



WARNING! Engine exhaust contains carbon monoxide, a poisonous gas that could kill you in minutes. You cannot smell it, see it, or taste it. Even if you do not smell exhaust fumes, you could still be exposed to carbon monoxide gas.

- Operate this product only outdoors, far away from windows, doors and vents to reduce the risk of carbon monoxide gas accumulating and the potential of being drawn towards occupied spaces.
- Install battery-operated carbon monoxide alarms or plug-in carbon monoxide alarms with battery back-up according to the manufacturer's instructions. Smoke alarms cannot detect carbon monoxide gas.
- Do not run this product inside homes, garages, basements, crawlspaces, sheds, or other partially-enclosed spaces even if using fans or opening doors and windows for ventilation. Carbon monoxide can quickly build up in these spaces and can linger for hours, even after this product has shut off.
- Point exhaust away from all homes and occupied spaces.

If you start to feel sick, dizzy, or weak while using this product, get to fresh air right away. See a doctor. You may have carbon monoxide poisoning.

Operation Location to Reduce the Risk of Fire



WARNING! Exhaust heat/gases could ignite combustibles, structures or damage fuel tank causing a fire, resulting in death or serious injury.

- Pressure washer must be at least 5 ft (1.5 m) from any structure, overhang, trees, windows, doors, and any wall opening, shrubs, or vegetation over 12 in. (30.5 cm) in height.

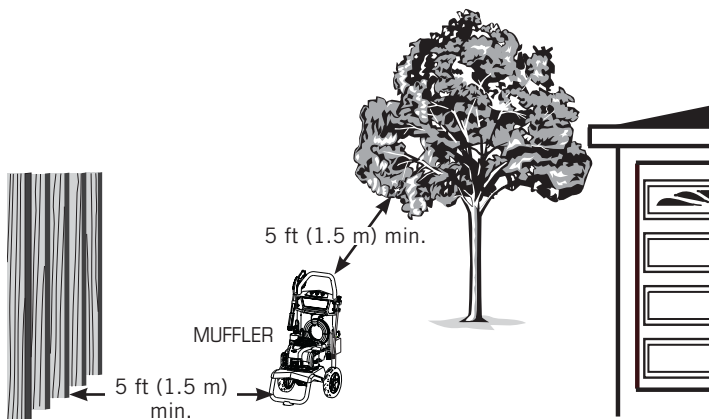

- Do not place pressure washer under a deck or other type of structure that may confine airflow. Smoke alarm(s) must be installed and maintained indoors according to the manufacturer's instructions /recommendations.
- Carbon monoxide alarms cannot detect smoke.
- It is a violation of California Public Resource Code Section 4442, to use or operate the engine on any forest-covered, brush-covered, or grass-covered land unless the exhaust system is equipped with a spark arrester, as defined in Section 4442, maintained in effective working order. Other states or federal jurisdictions may have similar laws, reference Federal Regulation 36 CFR Part 261.52.
- Contact the original equipment manufacturer, retailer, or dealer to obtain a spark arrester designed for the exhaust system installed on this engine.
- Replacement parts must be the same and installed in the same position as the original parts.

Step 2: Oil and Fuel

Check Oil Level



CAUTION! Avoid prolonged or repeated skin contact with used motor oil. Used motor oil has been shown to cause skin cancer in certain laboratory animals. Thoroughly wash exposed areas with soap and water.

1. Make sure pressure washer is on a level surface.
2. Clean the oil fill area of any debris.
3. Remove oil dipstick and wipe dipstick with clean cloth. Replace and tighten dipstick. Remove and check oil level.
4. Verify oil is at full mark (top hole) on dipstick. Replace and tighten dipstick.

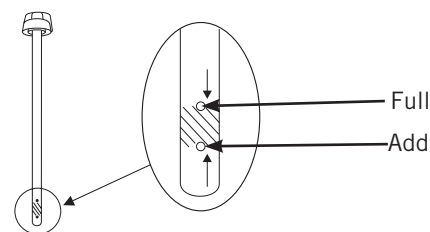

5. If needed, see *Maintenance* section for instructions to add oil.

Add Fuel

Fuel must meet these requirements:

- Clean, fresh, unleaded fuel with a minimum of 87 octane.
- Gasoline with an ethanol content up to 10% is acceptable.

E10

E15

NOTICE Do not mix oil in fuel or modify engine to run on alternate fuels. Unapproved fuels could damage engine. See *High Altitude* for operation above 5,000 ft (1524 m).



WARNING! Fuel and its vapors are extremely flammable which could cause burns or fire resulting in death or serious injury.

- Do not refuel during operation.
- Do not smoke during refueling.
- Turn engine off and let it cool at least 2 minutes before removing fuel cap.
- Fill fuel tank outdoors. Keep fuel away from ignition sources.

Operation

1. Slowly remove fuel cap to relieve pressure in tank.
2. Slowly add fuel to fuel tank. Do not fill above bottom of fuel tank neck to allow for fuel expansion.

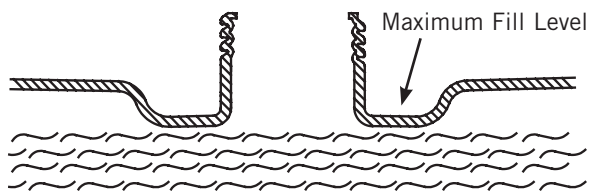

3. Install fuel cap and let any spilled fuel evaporate before starting engine.

High Altitude

At altitudes over 5,000 ft (1524 m), a minimum 85 octane fuel is acceptable. To remain emissions compliant, high altitude adjustment is required. Operation without this adjustment will cause decreased performance, increased fuel consumption, and increased emissions.

See an authorized Briggs & Stratton dealer for high altitude adjustment information. Operation of the engine at altitudes below 2,500 ft (762 m) with the high altitude kit is not recommended.

Transporting

Do not tip engine or equipment at an angle which causes fuel to spill.

Step 3: Set Up

Clean Debris

Clean any accumulated debris. Keep area around muffler free from any debris.

- Use a soft bristle brush to loosen caked on dirt or oil.
- Use a damp cloth to wipe exterior surfaces clean.

Lubricate O-rings

Lubricate all connections shown to extend the life of the o-rings.

1. Inspect and clean connecting surfaces prior to lubrication and assembly. Replace o-rings that are damaged or missing. See *Common Service Parts*.

NOTICE Never repair leaking connections with sealant of any kind. Replace o-ring.

2. Use a small brush or cotton swab to apply a light coating of grease directly to o-rings.

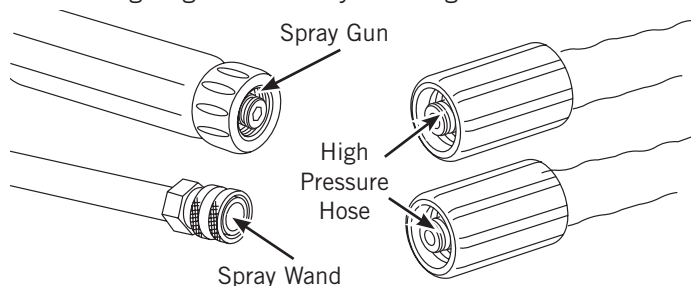

Check / Connect Gun and Hose

1. If spray gun trigger depresses without pressing trigger lock or if spray gun remains depressed when released, replace spray gun immediately.

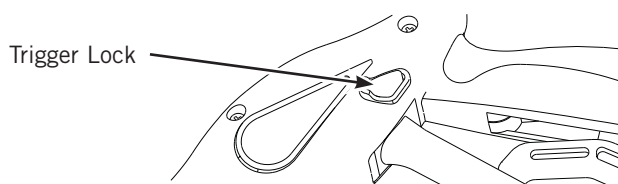

2. If high pressure hose is damaged, exposing inner mesh, replace immediately.
3. Attach high pressure hose to spray gun and high pressure outlet on pump. Tighten by hand.

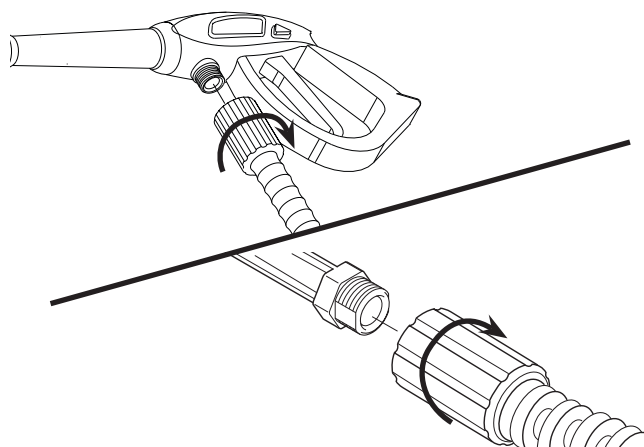

WARNING! The high pressure fluid could cut through skin and its underlying tissues, resulting in serious injury and possible amputation. Never attach spray wand directly to high pressure hose.

Check Water Inlet Screen / Connect Garden Hose

1. Inspect inlet screen. Remove debris or replace if damaged.

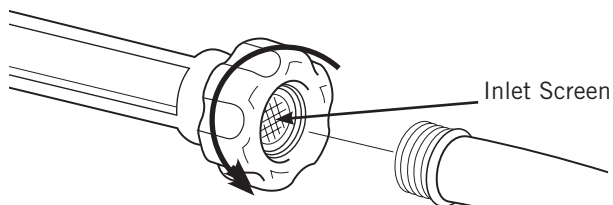

2. Run water through garden hose (not to exceed 50 ft (15 m) to clean out debris, then connect to water inlet.

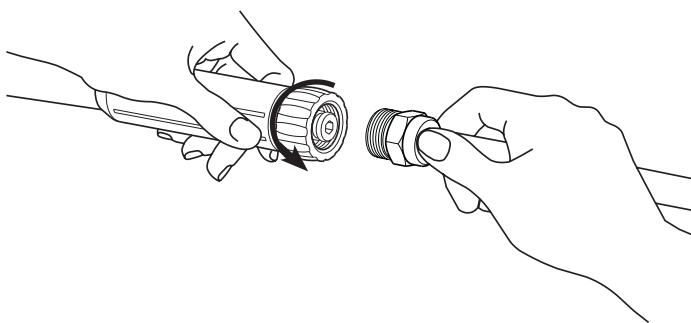

NOTICE There must be at least 10 ft (3 m) of unrestricted garden hose between the pressure washer inlet and any device, such as a vacuum breaker, to prevent pump damage.

3. Turn on water, point spray gun in safe direction, press trigger lock and depress trigger to purge pump system of air.
4. Attach spray wand to spray gun. Tighten by hand.

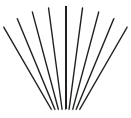
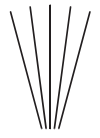

Step 4: Spray Tips

1. Select desired spray tip:

 <p>Low Pressure Black Soap Use to apply detergent</p>	 <p>Delicate Rinse White, 40° Cars / Vans / Trucks / Outdoor Furniture</p>
 <p>General Rinse Yellow, 15° Siding / Patios Decks Driveways / Garage Floors</p>	 <p>Maximum Rinse Red, 0° Paint Removal / Oil Stains /Rust Removal</p>

2. Pull spray wand quick connect collar back, insert spray tip and release. Tug spray tip to ensure it is secure.

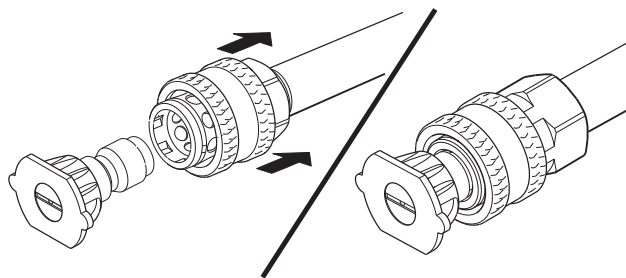

Operation

Step 5: Start Up

NOTICE Do not start engine without water supply connected and turned on.

1. Level product before starting.
2. Push engine switch to ON (I) position.

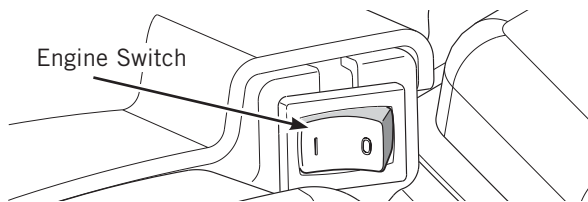

WARNING! Risk of eye injury. Spray could splash back or propel objects, resulting in serious injury.

- Always wear indirect vented (chemical splash) safety goggles when using or near this product. (Safety glasses do not provide full protection).
- Always wear protective clothing such as long-sleeved shirts, long pants and closed-toed shoes.

NOTICE A ReadyStart® engine requires no priming or choking.



WARNING! Recoil starter kickback (rapid retraction) will pull hand and arm toward engine faster than you can let go, which could cause broken bones, fractures, bruises, or sprains and result in serious injury.

3. Position yourself as shown below, grasp recoil starter and pull slowly until you feel some resistance. Then pull rapidly to start engine.
4. Return recoil starter slowly. Do not let rope “snap back” against starter.

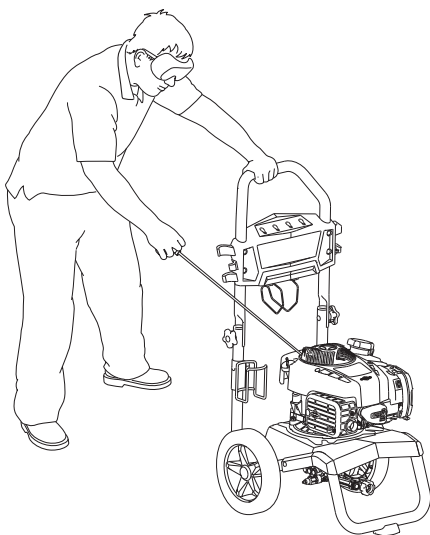

NOTICE Pressure washer is equipped with an automatic idle control. The idle control will lower engine speed when spray gun trigger is released.



WARNING! High-pressure water could cut through skin resulting in serious injury and possible amputation.

- Do not direct discharge at self or others.
- Call physician immediately if cut by fluid. Do not treat as a simple cut.
- Do not touch spray tips while spraying.



WARNING! Use of pressure washer could create slippery surfaces causing you to fall, resulting in death or serious injury. Kickback from spray gun could cause you to fall resulting in death or serious injury. Operate pressure washer from a stable surface.

5. Firmly grasp spray gun with both hands, point spray gun in safe direction, press trigger lock and depress trigger to begin spraying.



6. Apply high pressure spray to a small area first, then check the surface for damage. If no damage is found, it is okay to continue cleaning.



WARNING! Risk of electrocution. Contact with power source could cause electric shock or burn resulting in death or serious injury. Never spray near power source.

Usage Tips

- For most effective cleaning, keep spray tip 8 to 24 in (20 to 61 cm) away from cleaning surface.
- Do not use high pressure spray tips closer than 6 in (15 cm) to prevent damage to the cleaning surface.
- Start at the top of the area to be rinsed, working down with long, even, overlapping strokes.

Step 6: Applying Detergent



WARNING! Chemicals could cause burns resulting in death or serious injury.

- Follow chemical manufacturer's label instructions for proper use and handling of the chemical.
- Only use products marketed for use with pressure washers.
- Never spray flammable liquids.

Check Detergent Siphoning Tube / Tank

Clean detergent tube if clogged or replace if leaking.

To apply detergent, follow these steps:

1. Prepare pressure washer detergent per manufacturer's instructions.
2. Remove cap from detergent tank and fill with detergent solution. Replace cap.
3. Install black detergent spray tip. See *Spray Tips*.
4. Apply per manufacturer's instructions.

NOTICE Detergent cannot be applied with the high pressure spray tips (White, Yellow or Red).

Step 7: Shut Down

1. Release spray gun trigger and let engine idle for one minute.
2. Push engine switch to OFF (O) position.



WARNING! Spray gun traps high water pressure, even after engine shut down and water disconnection, which could result in serious injury.

injury.

3. Point spray gun in safe direction. Press trigger lock and depress trigger to relieve high water pressure.

Step 8: Clean Up

1. Turn off water and purge system.
2. Disconnect and drain all hoses, spray gun and spray wand.
3. Empty pump of all liquids by pulling recoil handle about six times.

NOTICE If storing in freezing temperatures or more than 30 days, see *Storage*.

Maintenance

Maintenance Schedule

Follow the hourly or calendar intervals, whichever occurs first.

Every 8 Hours or Daily (see Operation Section)
• Check engine oil level
• Clean debris
• Lubricate o-rings
• Check spray gun
• Check high pressure hose
• Check / clean water inlet screen
• Check detergent siphoning tube / tank
Every 50 Hours or Yearly
• Clean air cleaner
• Inspect muffler and if equipped, spark arrester
Every 200 Hours or Yearly
• Replace engine air cleaner
Yearly
• Replace spark plug
• Clean cooling system ^{1,2}

¹ Service more often under dirty or dusty conditions.

² See any authorized dealer for service.

General Recommendations

Regular maintenance will improve the performance and extend the life of the pressure washer. See any authorized dealer for service.

Pump Oil

Do not attempt any oil maintenance on this pump. The pump is pre-lubricated and sealed from the factory, requiring no additional maintenance for the life of the pump.

Detergent Siphoning Check Ball

The check ball in detergent siphoning system may become stuck from dried soap or minerals in water. The check ball can be freed by performing the following:



WARNING! Chemical Burn Hazard. Chemicals could cause burns resulting in death or serious injury. Follow chemical manufacturer's label instructions for proper use and handling of the chemical. Following *Shut Down*, remove detergent siphoning hose from barbed fitting on pump.

1. Insert paper clip, or similar device, into barbed fitting on pump and push down until ball moves.

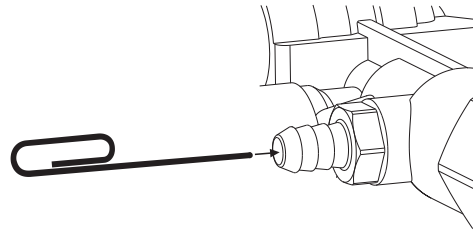

2. Reinstall detergent siphoning hose.

Spray Tip Maintenance

Clean an obstructed spray tip to correct a pulsing sensation when squeezing the spray gun trigger.

1. Following *Shut Down*, remove spray tip from spray wand.
2. Use a paper clip, or similar device, to free foreign material.

Engine Maintenance

Emissions Control

Maintenance, replacement, or repair of the emissions control devices and systems may be performed by any non-road engine repair establishment or individual. However, to obtain “no charge” emissions control service, the work must be performed by a factory authorized dealer. See the *Emissions Warranty*.

Oil Recommendations

We recommend the use of Briggs & Stratton Warranty Certified oils for best performance. Other high-quality detergent oils are acceptable if classified for service SF, SG, SH, SJ or higher. Do not use special additives.

Outdoor temperatures determine the proper oil viscosity for the engine. Use the chart to select the best viscosity for the outdoor temperature range expected. Engines on most outdoor power equipment operate well with 5W30 Synthetic oil. For equipment operated in hot temperatures, Vanguard® 15W50 Synthetic oil provides the best protection.

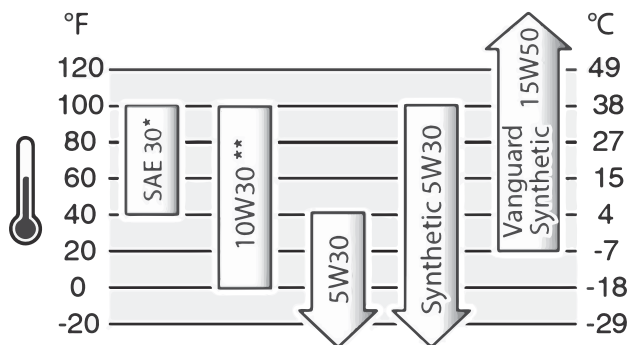

* Below 40°F (4°C) the use of SAE 30 will result in hard starting.

** Above 80°F (27°C) the use of 10W30 may cause increased oil consumption. Check oil level more frequently.

Add Engine Oil

1. Place pressure washer on level surface.
2. Clean area around oil fill and remove yellow oil fill cap/dipstick.
3. Slowly pour oil into oil fill opening. Checking oil level frequently, fill to full mark (top hole) on dipstick.

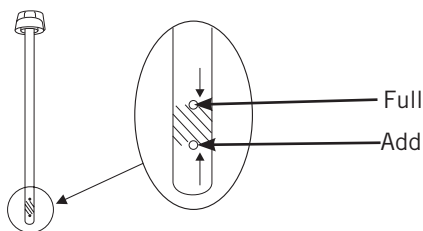

NOTICE Pause to permit oil to settle. Wipe dipstick clean each time oil level is checked. Do not overfill.

4. Replace and tighten dipstick.
5. Wipe up any remaining oil.

NOTICE Do not attempt to start engine before it has been properly serviced with oil. This could result in engine failure.



CAUTION! Avoid prolonged or repeated skin contact with used motor oil. Used motor oil has been shown to cause skin cancer in certain laboratory animals. Thoroughly wash exposed areas with soap and water.



KEEP OUT OF REACH OF CHILDREN. DO NOT POLLUTE. CONSERVE RESOURCES. RETURN USED OIL TO COLLECTION CENTERS.

Change Engine Oil

An oil change is not required. Follow the steps below if you want to change the oil.

Change oil while engine is still warm from running, as follows:

1. Drain fuel tank by running pressure washer until fuel tank is empty.
2. Disconnect spark plug wire and keep it away from spark plug.
3. Clean area around oil fill, remove oil fill cap/dipstick. Wipe dipstick clean.



WARNING! Contact with muffler area could cause burns resulting in serious injury. Lift by frame when tipping to avoid hot surfaces.

4. Tip pressure washer to drain oil from oil fill into a suitable container making sure to tip unit away from spark plug.
5. When engine is empty, return pressure washer to upright position.
6. Add recommended oil as described in *Add Engine Oil*.
7. Reconnect spark plug wire to spark plug.

Maintenance

Service Air Cleaner



WARNING! Fuel and its vapors are extremely flammable, which could cause burns or fire, resulting in death or serious injury.

- Do not start and run engine with air filter removed.

Your engine will not run properly and may be damaged if you run it with a dirty or missing air cleaner.

1. Pull the latch and open the cover.

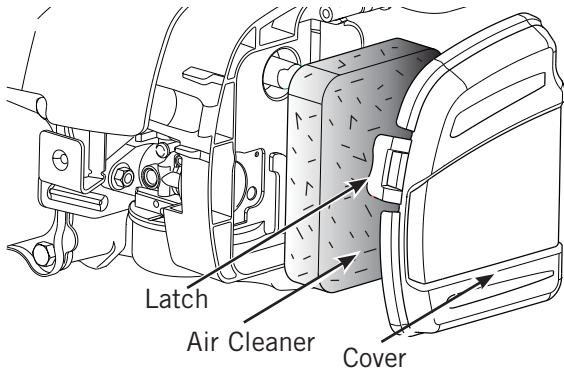

2. Carefully remove air cleaner to prevent debris from falling into carburetor.
3. Wash foam air cleaner in liquid detergent and water. Squeeze dry in a clean cloth.
4. Saturate foam air cleaner in new engine oil and squeeze in a clean cloth to remove excess oil.
5. Reinstall clean or new air cleaner in base.
6. Close the cover and secure the latch.

Service Spark Plug

Changing the spark plug will help your engine to start easier and run better.

1. Clean area around spark plug.
2. Remove and inspect spark plug.
3. Replace spark plug if electrodes are pitted, burned or porcelain is cracked. Use the recommended replacement spark plug. See *Common Service Parts*.
4. Check electrode gap with wire feeler gauge and reset spark plug gap to recommended gap if necessary (see *Specifications*).

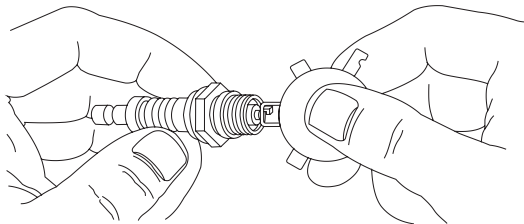

5. Install spark plug and tighten firmly.

Inspect Muffler and Spark Arrester

Inspect the muffler for cracks, corrosion, or other damage. Remove the spark arrester, if equipped, and inspect for damage or carbon blockage. Clean if carbon blockage is found using brush and commercial solvent or replace if damaged.



WARNING! Contact with muffler area could cause burns resulting in serious injury. Do not touch hot parts.

Common Service Parts

Pump Saver™	6039
O-ring Maintenance Kit	705001
Water Inlet Screen	B2384GS
Air Cleaner	595297
Spark Plug	594264
Engine Oil Bottle	100005 or 100028

Contact an authorized service dealer or BRIGGSandSTRATTON.com for a full list of parts and diagrams.

Storage



WARNING! Fuel and its vapors are extremely flammable, which could cause burns or fire, resulting in death or serious injury. Do not store fuel near ignition source.

1. Empty detergent tank as follows:
 - a. Place suitable container under barbed fitting on detergent tank and remove detergent tube. Remove the tanks cover, tip pressure washer forward slightly and empty tank contents into container.
 - b. Reconnect hose to barbed fitting on tank.
 - c. Add 1 pint (0.5 liter) of clean fresh water to detergent tank and close tanks cover.
2. Flush detergent tank by running pressure washer with the black spray tip. Flush until tank is empty.

Protecting Fuel System

3. Treat or drain fuel from pressure washer as fuel can become stale when stored over 30 days.

Each time you fill the container with fuel, add STA-BIL 360°® PROTECTION™ to the fuel as specified by the manufacturer's instructions. This keeps fuel fresh and decreases fuel-related problems or contamination in the fuel system.

It is not necessary to drain fuel from the engine when STA-BIL 360°® PROTECTION™ is added as instructed. Before storage, turn the engine ON for 2 minutes to move the fuel and stabilizer through the fuel system.

If fuel in the engine has not been treated with STA-BIL 360°® PROTECTION™, it must be drained into an approved container. Then run the engine until it stops from lack of fuel.

Protecting the Pressure Washer

4. Turn off water and purge system.
5. Disconnect and drain all hoses, spray gun and spray wand.
6. Empty pump of all liquids by pulling recoil handle about six times.

NOTICE Store spray gun indoors and keep from freezing.

Protecting the Pump

7. Treat pump with Pump Saver.

Use Pump Saver to protect pump from damage caused by mineral deposits and freezing. It also lubricates pistons and seals. See *Common Service Parts*.

Read and follow all Pump Saver warnings and instructions.

If Pump Saver is not available, connect a 3 ft (1 m) section of garden hose to water inlet. Pour RV-antifreeze (antifreeze without alcohol) into hose. Pull recoil handle twice. Disconnect hose.

NOTICE You must protect your product from freezing temperatures. Failure to do so will permanently damage your pump and spray gun rendering your product inoperable.

8. Store unit in a clean and dry area.



WARNING! Storage covers could cause a fire resulting in death or serious injury. Do not place a storage cover over a hot pressure washer. Let product cool before installing cover.

Pump Saver Storage

1. On the back of the accessory tray, insert rubber strap into first opening until it locks.
2. Set the Pump Saver bottle in the space between the two slots.

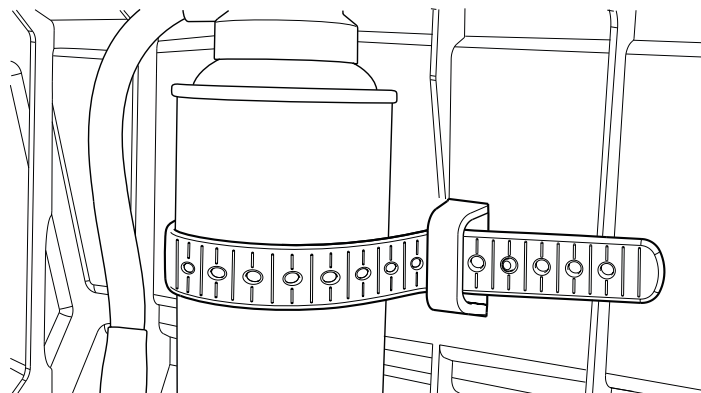

3. Wrap the strap over the bottle and feed through the slot and hook onto knob.

Troubleshooting

Problem	Cause	Correction
Pump has following problems: failure to produce pressure, loss of pressure, low water volume.	<ol style="list-style-type: none"> 1. Low pressure spray tip installed. 2. Inadequate water supply. 3. Clogged inlet hose screen. 4. Spray tip is obstructed. 5. Connections leak. 6. High pressure hose or spray gun leaks. 	<ol style="list-style-type: none"> 1. Replace with high pressure spray tip. 2. Provide adequate water flow. 3. Check and clean inlet hose screen. 4. Clean spray tip. See <i>Spray Tip Maintenance</i>. 5. Tighten connections or replace o-rings. 6. Replace.
Detergent fails to mix with spray.	<ol style="list-style-type: none"> 1. High pressure spray tip installed. 2. Check ball stuck in detergent siphoning system. 3. Detergent siphoning tube is clogged or cracked. 	<ol style="list-style-type: none"> 1. Replace with low pressure black spray tip. 2. Free check ball. See <i>Detergent Siphoning Check Ball</i>. 3. Clean or replace detergent siphoning tube.
Engine will not start; starts and runs rough or shuts down during operation.	<ol style="list-style-type: none"> 1. Engine switch set to OFF (O) position. 2. Out of fuel. 3. Flooded with fuel. 4. Dirty air cleaner. 5. Spark plug wire not connected to spark plug. 	<ol style="list-style-type: none"> 1. Set engine switch to ON (I) position. 2. Fill fuel tank. 3. Wait 5 minutes before starting. 4. Clean or replace air cleaner. 5. Connect wire to spark plug.
Idle control not functioning.	Idle control cable is loose.	Contact local authorized dealer.
For all other issues, see a Briggs & Stratton authorized dealer.		

Specifications

White, 40°	2400 PSI (165 bar) @ 2.5 GPM (9.5 L/min)*
Yellow, 15°	2800 PSI (193 bar) @ 2.4 GPM (9.1 L/min)*
Red, 0°	3000 PSI (207 bar) @ 2.1 GPM (7.6 L/min)*
Water Supply Temperature	41°F (5°C) - 100°F (38°C)
min Water Supply Flow Rate	3.5 GPM (13.25 L/min)
min Water Supply Pressure	20 PSI (1.38 bar)
Engine Displacement	11.58 in ³ (190 cc)
Spark Plug Gap	0.020 in. (0.050 mm)
Oil Capacity	20 oz (0.6 L)

Power Ratings: The gross power rating for individual gasoline engine models is labeled in accordance with SAE (Society of Automotive Engineers) code J1940 Small Engine Power & Torque Rating Procedure, and is rated in accordance with SAE J1995. Torque values are derived at 2600 RPM for those engines with “rpm” called out on the label and 3060 RPM for all others; horsepower values are derived at 3600 RPM. The gross power curves can be viewed at www.BRIGGSandSTRATTON.COM. Net power values are taken with exhaust and air cleaner installed whereas gross power values are collected without these attachments. Actual gross engine power will be higher than net engine power and is affected by, among other things, ambient operating conditions and engine-to-engine variability. Given the wide array of products on which engines are placed, the gasoline engine may not develop the rated gross power when used in a given piece of power equipment. This difference is due to a variety of factors including, but not limited to, the variety of engine components (air cleaner, exhaust, charging, cooling, carburetor, fuel pump, etc.), application limitations, ambient operating conditions (temperature, humidity, altitude), and engine-to engine variability. Due to manufacturing and capacity limitations, Briggs & Stratton may substitute an engine of higher rated power for this engine.

*This pressure washer is rated in accordance to the Pressure Washer Manufacturers’ Association (PWMA) standard PW101-2010 (Testing and Rating Performance of Pressure Washers).

CRAFTSMAN WARRANTY POLICY

LIMITED WARRANTY

Craftsman® is a registered trademark of Stanley Black & Decker Inc. and is used under license to Briggs & Stratton. Briggs & Stratton warrants that, during the warranty period specified below, it will repair or replace, free of charge, any part that is defective in material or workmanship or both. Transportation charges on product submitted for repair or replacement under this warranty must be borne by purchaser. This warranty is effective for and is subject to the time periods and conditions stated below. For warranty service, find the nearest Authorized Service Dealer in our dealer locator map at BRIGGSANDSTRATTON.COM. The purchaser must contact the Authorized Service Dealer, and then make the product available to the Authorized Service Dealer for inspection and testing.

There is no other express warranty. Implied warranties, including those of merchantability and fitness for a particular purpose, are limited to the warranty period listed below, or to the extent permitted by law. Liability for incidental or consequential damages are excluded to the extent exclusion is permitted by law. Some states or countries do not allow limitations on how long an implied warranty lasts, and some states or countries do not allow the exclusion or limitation of incidental or consequential damages, so the above limitation and exclusion may not apply to you. This warranty gives you specific legal rights and you may also have other rights which vary from state to state or country to country.**

WARRANTY PERIOD

Item	Consumer Use	Commercial Use
Equipment	24 months	3 months
Engine*	24 months	3 months
Frame	36 months	3 months

* Applies to Briggs & Stratton engines only. Warranty coverage of non-Briggs & Stratton engines is provided by that engine manufacturer. Emissions-related components are covered by the Emissions Warranty Statement.

** In Australia - Our goods come with guarantees that cannot be excluded under the Australian Consumer Law. You are entitled to a replacement or refund for a major failure and for compensation for any other reasonably foreseeable loss or damage. You are also entitled to have the goods repaired or replaced if the goods fail to be of acceptable quality and the failure does not amount to a major failure. For warranty service, find the nearest Authorized Service Dealer in our dealer locator map at BRIGGSandSTRATTON.COM, or by calling 1300 274 447, or by emailing or writing to salesenquires@briggsandstratton.com.au, Briggs & Stratton Australia Pty Ltd, 1 Moorebank Avenue, NSW, Australia, 2170.

The warranty period begins on the date of purchase by the first retail or commercial consumer. "Consumer use" means personal residential household use by a retail consumer. "Commercial use" means all other uses, including use for commercial, income producing or rental purposes. Once a product has experienced commercial use, it shall thereafter be considered as a commercial use product for purposes of this warranty.

Save your proof of purchase receipt. If you do not provide proof of the initial purchase date at the time warranty service is requested, the manufacturing date of the product will be used to determine the warranty period. Product registration is not required to obtain warranty service on Briggs & Stratton products.

ABOUT YOUR WARRANTY

Warranty service is available only through Briggs & Stratton Authorized Service Dealers. This warranty covers only defects in materials or workmanship. It does not cover damage caused by improper use or abuse, improper maintenance or repair, normal wear and tear, or stale or unapproved fuel.

Improper Use and Abuse - The proper, intended use of this product is described in the Operator's Manual. Using the product in a way not described in the Operator's Manual or using the product after it has been damaged will not be covered under this warranty. Warranty coverage will also not be provided if the serial number on the product has been removed or the product has been altered or modified in any way, or if the product has evidence of abuse such as impact damage or water/chemical corrosion damage.

Improper Maintenance or Repair - This product must be maintained according to the procedures and schedules provided in the Operator's Manual, and serviced or repaired using genuine Briggs & Stratton parts or equivalent. Damage caused by lack of maintenance or use of non-original parts is not covered by warranty.

Normal Wear and Tear - Like most mechanical devices, your unit is subject to wear even when properly maintained. This warranty does not cover repairs when normal use has exhausted the life of a part or the equipment. Maintenance and wear items such as filters, belts, cutting blades, and brake pads (except engine brake pads) are not covered by warranty due to wear characteristics alone, unless the cause is due to defects in material or workmanship.

Stale or Unapproved Fuel - In order to function correctly, this product requires fresh fuel that conforms to the criteria specified in the Operator's Manual. Engine or equipment damage caused by stale fuel or the use of unapproved fuels (such as E15 or E85 ethanol blends) is not covered by warranty.

Other Exclusions - This warranty excludes damage due to accident, abuse, modifications, alterations, improper servicing, freezing or chemical deterioration. Attachments or accessories that were not originally packaged with the product are also excluded. There is no warranty coverage on equipment used for primary power in place of utility power or on equipment used in life support applications. This warranty does not include used, reconditioned, second-hand, or demonstration equipment or engines. This warranty also excludes failures due to acts of God and other force majeure events beyond the manufacturer's control.



CRAFTSMAN®

Pressure Washer

WWW.CRAFTSMAN.COM

1-888-331-4569

CRAFTSMAN® is a registered trademark of Stanley Black & Decker, Inc., used under license.

CMXGWAS020733

**Briggs & Stratton Corporation
Milwaukee, Wisconsin, 53201-0702 U.S.A.**